

Elica Concept



The finest cooker hoods in the world

D R Cooker Hoods

Elica. The finest cooker hoods in the world

Manufactured in Italy for over thirty years, Elica Cooker Hoods adorn millions of kitchens across the globe. Beautiful, distinctive and stylish, they are more than just cooker hoods, they are a feast for the eyes and the senses...

Elica Collection

The Elica Collection represents the pinnacle of the entire Elica range. These unique cooker hoods, including models created by David Lewis, the renowned international designer, are universally acclaimed for their matchless design and innovative technology.

Both aesthetically and in terms of quiet performance, this prestigious collection creates a stunning focal point for contemporary kitchen design - truly a breath of fresh air in form and function.

The Collection includes wall mounted, island and built-in hoods.

Please ask for our *Elica Collection* brochure.

Elica Concept

Elica Concept products define themselves by their extraordinary elegance and effortless efficiency. They cleverly combine an inspired choice of materials with an unparalleled dedication to design detail. The result is that their innovative solutions transform any kitchen they grace.

Traditional Models

Contemporary styling in stainless steel, aluminium or glass won't fit all kitchens. That's why we also have traditional integrated cooker hoods, built-in cooker hoods as well as models specially designed for use with range cookers - in all colours!

Choosing a Cooker Hood

One of the key things to consider is style and look. But to ensure your choice gives optimum performance it should be at least as wide as your oven or hob.

Will your choice be ducted to the outside of the house? If so, the ducting needs to be the right size; a cooker hood installed with the correct ducting will extract virtually all the steam, cooking odours and airborne grease from the kitchen. If however, it's impractical to install ducting in your home, then charcoal filters can be used to re-circulate fresher air around the room.

Whichever method chosen, Elica adopt only the latest European standards when measuring the efficiency of their products. That's why Elica cooker hoods are recognised around the world for their unsurpassed performance.

Contents

- 4 Advanced Cooker Hood Technology

Elica Concept

- 6 Ala
- 7 Cube
- 8 Feeling
- 9 Glacier
- 10 Igloo
- 11 Key
- 12 Polar
- 13 Spot
- 14 Stone
- 15 Tamaya
- 16 Tonda
- 17 Tuscan
- 18 Typhoon
- 19 Zephyr

Elica Concept Islands

- 20 Fiji Island
- 21 Free Spot Island
- 22 Glacier Island
- 23 Iceberg Island
- 24 Tuscan Island

Elica Concept Corners

- 25 Hydra Corner

Traditional/Accessories

- 26 Range Style Hoods / Canopies
- 28 Built In
- 31 Integrated
- 33 Freestanding Hoods
- 34 Accessories
- 35 Ducting

Appendices

- 36 Dimensional Drawings
- 37 Technical Specifications
- 39 Index to Symbols

Advanced Cooker Hood Technology

Automatic Sensor Technology

AST

Imagine a cooker hood that can react automatically to conditions within the kitchen. AST, an innovation developed by Elica, enables the hood to do just that! Three individual sensors, which measure heat, ambient temperature, humidity and can switch the hood on and off accordingly, as well as adjust and control the extraction power. It can do all this for any type of hob: gas, electric or induction.

Among the many benefits of the AST system are: improved ventilation, better air quality, optimised noise levels as well as reduced energy consumption. Naturally, you can manually override the AST system at any time.

See our *Elica Collection* brochure for models featuring AST.



Perimeter Aspiration

By use of an alternative extraction method, airflow can be directed to the outer edges of the cooker hood. In this way, the entire external perimeter of the hood is utilised, thus reducing energy consumption and also noise.

See our *Elica Collection* brochure for models featuring Perimeter Aspiration.



Advanced Cooker Hood Technology

Meteo



Meteo is the name we give to our advanced electronic control and communication system. Meteo's digital display constantly updates you with information about the current status of the cooker hood - extraction speeds, conditions of filters etc.

But that is only part of the story. Add to this a handy digital clock, an indispensable kitchen timer with alarm, an external sensor for providing information, including temperature, pressure as well as a weather forecast and you get an idea of just how versatile Meteo can be.

See our *Elica Collection* brochure for models featuring Meteo.



External motors

Many models now offer the benefit of external motors. Here, the motor unit is located outside the hood - either in a loft space or on an outside wall - so achieving far superior performance and noise reduction.



Remote Control

For even greater convenience, some models allow you to operate the cooker hood by remote control. Both the lighting and extraction can be controlled from our unique radio controlled handset.

See our *Elica Collection* brochure for models featuring Remote Control.



ALA

*New introduction for this
low profile chimney hood
in stainless steel with
illuminated glass trim.*



- 4 speed electronic touch control with filter saturation indicators
- 2 x 11w fluorescent lamps
- Metal washable grease filter
- 150mm (6in) diameter ducting connector
- 90cm wide
- Airflow to 750 m³/h



Low profile hood
stainless steel with
glass trim.

CUBE



- 3 speed soft push buttons
- 2 x 20w halogen lamps
- Metal washable grease filter
- 150mm (6in) diameter ducting connector
- Smart installation system
- 60 or 90cm wide
- Airflow to 750 m³/h
- Available with external motor (1200 m³/h)



FEELING

*Sleek stainless steel canopy
style designer hood*



- 3 speed slider controls
- 2 x 20w halogen lamps
- Metal washable grease filters
- 150mm (6in) diameter ducting connector
- 90cm wide
- Airflow to 750 m³/h

An aesthetically pleasing combination of stainless steel and glass.

GLACIER



- 3 speed soft push buttons
- 2 x 20w halogen lamps
- Metal washable grease filter
- 150mm (6in) diameter ducting connector
- Smart installation system
- 60, 70, 80, 90 100, 110 or 120cm wide
- Airflow to 750 m³/h
- Available with external motor (1200 m³/h)

IGLOO

*Toughened curved glass
beautifully crafted beneath
the classic stainless steel
structure.*

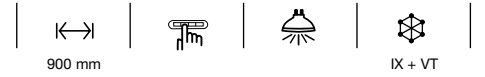

- 3 speed push button controls
- 2 x 20w halogen lamps
- Metal washable grease filter
- 150mm (6in) diameter ducting connector
- 90cm wide
- Airflow to 750 m³/h
- Chimney flue extensions available

A classic design stainless steel hood with our highest specification motor.

KEY

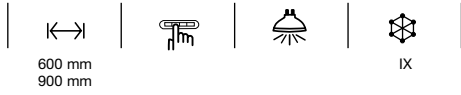

- 3 speed push button controls
- 2 x 20w halogen lamps
- Metal washable grease filters
- 150mm (6in) diameter ducting connector
- 60 or 90cm wide
- Airflow to 750 m³/h
- Chimney flue extensions available



POLAR

A new version of our already popular stainless steel Glacier but with curved glass.



- 3 speed push button controls
- 2 x 20w halogen lamps
- Metal washable grease filter
- 150mm (6in) diameter ducting connector
- Smart installation system
- 90cm wide
- Airflow to 750 m³/h
- Available with external motor (1200 m³/h)



*Aesthetically appealing
stainless steel combined
with solid construction*

SPOT



- 3 speed push button controls
- 2 x 20w halogen lamps
- Metal washable grease filters
- 150mm (6in) diameter ducting connector
- Smart installation system
- 60, 90 or 120cm wide
- Optional 90cm wide shelf with dish rack available
- Airflow to 750 m³/h



STONE

Semi round stainless steel chimney hood, ideal if space is at a premium.

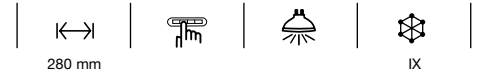

- 3 speed illuminated soft push button
- 2 x 20w halogen lamps
- Metal washable grease filter
- 150mm (6in) diameter ducting connector
- Smart installation system
- 28cm wide
- Airflow to 750 m³/h

Enduringly popular and
available in 4 widths.

TAMAYA

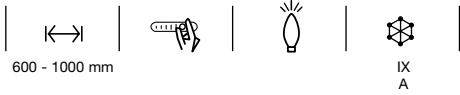

- 3 speed slider controls
- 2 x 40w hob lamps
- Metal washable grease filters
- 125mm (5in) diameter ducting connector
- 60 or 90cm wide – black or white
- 60, 70, 90, 100cm wide – stainless steel
- Airflow to 480 m³/h
- Stainless steel chimney extensions available

TONDA

This semi round stainless steel chimney hood for the "curved" look kitchen.

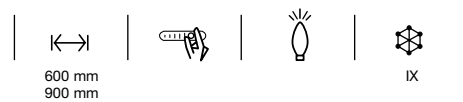

- 3 speed slider controls
- 2 x 40w hob lamps
- Metal washable grease filters
- 125mm (5in) diameter ducting connector
- 60 or 90cm wide
- Airflow to 480 m³/h

The stainless steel Tuscan chimney hood combining performance and traditional quality.

TUSCAN

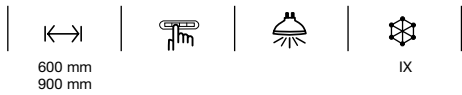

- 3 speed soft push button
- 2 x 20w halogen lamps
- Metal washable grease filter
- 150mm (6in) diameter ducting connector
- Smart installation system
- 60 or 90cm wide
- Airflow to 750 m³/h



TYPHOON

*Typhoon, a traditional style
stainless steel chimney hood.*

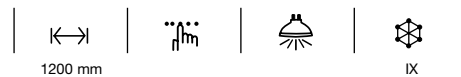

- 4 speed electronic touch control with filter saturation indicators
- 3 x 20w halogen lamps
- Metal washable grease filters
- 125mm (5in) diameter ducting connector
- 120cm wide
- Airflow to 600 m³/h



*Soft shape stainless steel
for designers curved
kitchen effect.*

ZEPHYR



- Variable slider controls
- 14w fluorescent lamp
- Metal washable grease filter
- 125mm (5in) diameter ducting connector
- 90cm wide
- Airflow to 480 m³/h
- Zephyr can be adapted to be used with a remote (by cable) switch. Order part number 213452 as an optional extra



FIJI ISLAND

Our original stainless steel island hood, still a firm favourite.

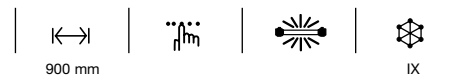

- 4 speed electronic touch control with filter saturation indicators
- 2 x 14w fluorescent lamps
- Metal washable grease filters
- 150mm (6in) diameter ducting connector
- 90 x 60cm
- Airflow to 750 m³/h

*Pleasing stainless steel
Island hood with a choice
of two sizes*

FREE SPOT
ISLAND

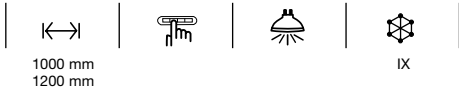

- 3 speed push button controls
- 4 x 20w halogen lamps
- Metal washable grease filters
- 150mm (6in) diameter ducting connector
- 100 x 60cm or 120 x 60cm
- Airflow to 750 m³/h

GLACIER ISLAND

Stylish stainless steel and glass chimney hood. Glacier has a flat curved edge glass.



- 3 speed soft push buttons
- 4 x 20w halogen lamps
- Metal washable grease filter
- 150mm (6in) diameter ducting connector
- 100 x 70cm
- Airflow to 750 m³/h
- Available with external motor (1200 m³/h)

*Iceberg in stainless steel
with curved glass is a
gleaming gem amongst our
island models.*

ICEBERG
ISLAND



- 3 speed push button controls
- 4 x 20w halogen lamps
- Metal washable grease filter
- 150mm (6in) diameter ducting connector
- 100 x 70cm
- Airflow to 750 m³/h
- Available in 3x heights, 692-872mm, 812-976mm or 1000-1360mm



TUSCAN ISLAND

A hi-tech slim line stainless steel chimney hood with beautiful formed rounded corners.



- 3 speed soft push buttons
- 4 x 20w halogen lamps
- Metal washable grease filter
- 150mm (6in) diameter ducting connector
- 90 x 60cm
- Airflow to 750 m³/h



Our stainless steel corner chimney hood presents a stunning solution for the designer requiring a corner cooker hood.

HYDRA
CORNER

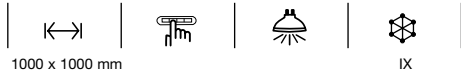

- 3 speed push button controls
- 4 x 20w halogen lamps
- Metal washable grease filters
- 150mm (6in) diameter ducting connector
- 100 x 100cm
- Airflow to 750 m³/h



COVE

Designed for professional style range cookers.

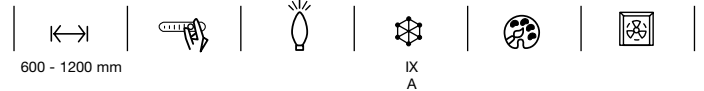

- Includes built in super twin 60
- 3 speed slider controls
- 2 x 40w hob lamps
- Metal washable grease filters
- 125mm (5in) ducting connector
- 60, 90, 100, 110 or 120cm wide
- Airflow to 480 m³/h
- Available with our high performance (1200 m³/h) built in remote 60
- Stainless steel, black, white, blue, green, maroon, cream



CLASSIC

Stylish and powerful canopy hood in the style and colours to enhance range cookers.



- Includes built in super twin 80
- 3 speed slider controls
- 2 x 40w hob lamps
- Metal washable grease filters
- 125mm (5") ducting connector
- 90, 100, 110, 120 cm wide
- Airflow to 480 m³/h
- Available with built in ultra or our high performance (1200 m³/h) built in remote 80
- A taylor made chimney flue can be ordered as an optional extra
- Stainless steel, black, white, blue, green, maroon, cream



Designed to enhance range cookers and hobs – for the serious cook!

PRO-ANGLO

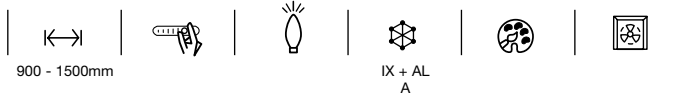

- 3 speed slider controls
- Hob lamps
- Metal washable grease filters
- Available 90, 100, 120 or 150cm wide
- Airflow to 960 m³/h (120/150cm models only)
- Airflow to 480 m³/h (90/100cm models only)
- Stainless steel with black etched aluminium panel.
- Available with remote motors (1200 m³/h) for higher performances
- Colours to special order: black, white, blue green, maroon or cream



Copper and brass hand made canopies are finished with a clear hard lacquer to protect the natural material.

COPPER &
BRASS
CANOPIES



- Includes built in 52
- 3 speed slider controls
- 2 x 40w hob lamps
- Disposable grease filter
- 100mm (4") ducting connector
- 60 or 90cm wide
- Rippled copper, hammered copper, copper rose or antique brass
- Airflow to 270 m³/h
- Available with built in super twin & built in remote

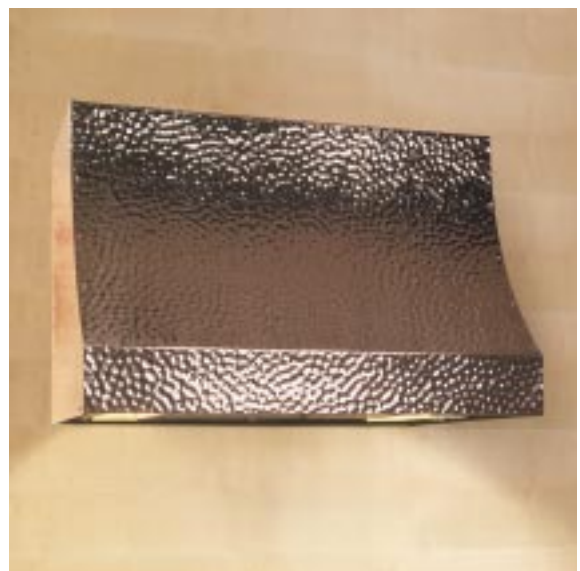

BUILT IN
REMOTE
60 & 80

Offers a wider choice of powerful ventilation and less noise in the kitchen.



- Stainless steel encased external motor
- Variable slider control
- 2 x 20w halogen lamps
- Washable metal grease filters
- 150mm (6in) diameter ducting connector
- 52 or 72cm wide
- Remote motor casing 450mm wide, 480mm high, 170mm deep
- Ducting version only
- Airflow to 1200 m³/h
- Grey

BUILT IN
ULTRA
80

Our Ultra High Spec. built-in hood has twin tangential fans for high performance and halogen lights to illuminate the cooking area.



- 4 speed slider controls
- 2 x 20w halogen lamps
- Washable metal grease filters
- 150mm (6in) diameter ducting connector
- 72cm wide
- Airflow to 700 m³/h
- Black or Grey



Our Deluxe built-in hood can be remotely controlled by means of the de-mountable switch unit and 3 metre cable, allowing the controls to be placed in a worktop or plinth for easy access and use.

BUILT IN
DELUXE
60



- Twin Motor
- Variable slider control
- 14w fluorescent lamp
- Washable metal grease filter
- 125mm (5in) diameter ducting connector
- 55cm wide
- Stainless steel
- Airflow to 480 m³/h



For fitting into larger canopies and featuring twin motors for high performance.

BUILT IN
SUPER TWIN
60 & 80



- Twin motor
- 3 speed slider controls
- 2 x 40w hob lamps
- Washable metal grease filters
- 125mm (5in) diameter ducting connector
- 52 or 72cm wide
- Airflow to 480 m³/h
- Black, white or grey (52cm) black or white (72cm)

BUILT IN
SUPER
60

*For fitting into smaller
purpose built canopies.*



- 3 speed slider controls
- 2 x 40w hob lamps
- Washable metal grease filters
- 100mm (4in) diameter ducting connector
- 52cm wide
- Airflow to 280 m³/h
- Black or white



BUILT IN 52

*For fitting into small
purpose built canopies.*



- 3 speed slider controls
- 2 x 40w hob lamps
- Painted metal air inlet tray with disposable grease filter
- 100mm (4in) diameter ducting connector
- 52cm wide
- Airflow to 280 m³/h
- Black, white or grey



INTEGRATED ULTRA

Our 60cm Ultra High Spec. hood is our top of the range integrated model. This hood has the facility to duct horizontally from the back within the height of the appliance using the duct connector supplied.



- Twin motors
- 4 speed slider controls
- 14w fluorescent lamp
- Washable metal grease filters
- 125mm (5in) diameter ducting connector
- 60cm wide
- Airflow to 540 m³/h
- Grey



INTEGRATED SUPER

Integrated 60cm cooker hood with single motor and the facility to duct horizontally from the back within the height of the appliance using the duct connector supplied.



- 3 speed slider controls
- 2 x 40w hob lamps
- Washable metal grease filters
- 100mm (4in) diameter ducting connector
- 60cm wide
- Airflow to 300 m³/h
- Grey



INTEGRATED 60 & 90

*Integrated hood available
in 60cm and 90cm widths.
Single motor and
disposable grease filters.*

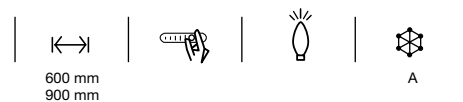

- 3 speed slider controls
- 2 x 40w hob lamps
- Disposable fibre filter
- 100mm (4in) diameter ducting connector
- 60cm white, brown or grey
- 90cm grey
- Airflow to 270 m³/h



SLIDE AWAY

*Our Slideaway cooker hood
fits into the cupboard space
above the hob. The slimline
front panel can be removed
and replaced with a lighting
pelmet to match kitchen units.*



- 3 speed slider controls
- 2 x 40w hob lamps
- Washable metal grease filters
- 125mm diameter ducting connector
- Grey
- Airflow to 270 m³/h



A stylish slim-line freestanding hood to suit every installation.

CONCORDE



Concorde

- Single motor
- 3 speed slider control
- 2 x 40w hob lamps
- Disposable grease filter
- Includes charcoal filter type 190
- 100mm (4") ducting connector
- 60cm wide
- Black, white or black with stainless steel front panel
- Can be ducted top or rear
- Adjustable glass visor
- Airflow to 250 m³/h

Concorde Twin

- Twin motor
- 3 speed slider control
- 2 x 40w hob lamps
- Metal washable grease filter
- Includes charcoal filter type 190
- 125mm (5") ducting connector
- 60 or 90cm wide
- Black, white or stainless steel
- Can be ducted top or rear
- Adjustable glass visor
- Airflow to 400 m³/h



Traditional styling combined with efficiency.

CHIC



- 3 speed slider controls
- 40w hob lamp
- Disposable grease filter.
- Includes type 50 charcoal filter.
- 100mm (4") ducting connector
- Can be ducted from the top or rear.
- Adjustable tinted visor
- 60cm wide.
- Available black, brown or white
- Airflow to 230 m³/h





Backplates

For a practical solution and professional appeal use our stainless steel back plates. They are reinforced with MDF and are available in 60, 70, 80, 90, 100, 110 or 120cm widths and 650 or 750mm heights. The new fitting flanges with depths of 20mm and 36mm make them suitable for almost all cooker hoods including our Glacier models.

Utensil Sets

No kitchen is complete without those extra finishing touches. Our 5 piece utensil set, complete with hooks, is designed to coordinate with Elica cooker hoods. Chrome utensil bars, 60, 90 or 120cm wide including hooks are also available, as are additional packs of 5 hooks.

Chimney Kits

To accommodate different kitchen installations we offer stainless steel chimney extension kits for Igloo, Key and Tamaya. Short kits for Key and Tamaya are also available.



Plate Rack and Shelf

Our unique plate rack and shelf, provides an ingenious and attractive space saving solution. It has been designed to complement the Spot cooker hoods but can be effectively used as a standalone unit.

Plinth Heaters

A 2 kW built-in electric fan heater designed for installation in standard kitchen furniture plinths with 1 kW and 2 kW heat settings and neon indicator.



Rainbow colour match system

All our hoods can be colour coded to your swatch or matched from our library of paint swatches, RAL or BS paint codes.



100mm (4") nominal

DK 4/9 3M long

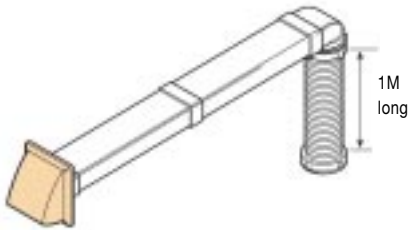

DK 4/3 1M long
DK 4/4 2M long
DK 4/5 3M long

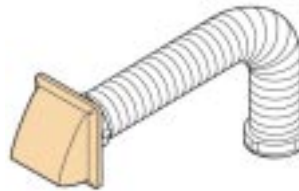

UB41



125mm (5") nominal

DK 5/8 3M long

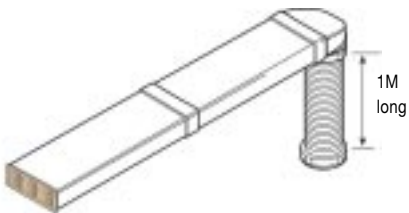

DK 5/2 1M long
DK 5/3 2M long
DK 5/4 3M long

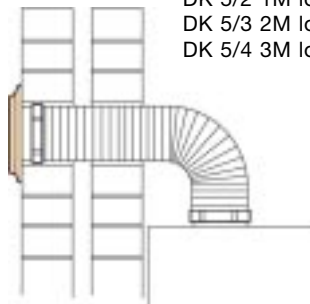

DK 5/11 Return air box



150mm (6") nominal

DK 6/7 3M long

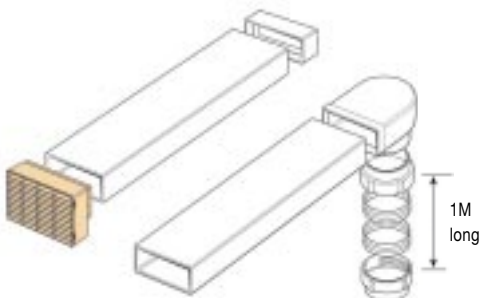

DK 6/1 1M long
DK 6/2 2M long
DK 6/3 3M long

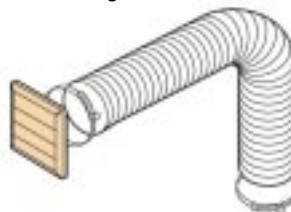

DK 6/100 1M long



Please ask to see separate FleeFlow Ducting leaflet for a complete range of ducting kits and components.

IMPORTANT

The ducting chosen must be at least the same area as the connector on the cooker hood. The use of smaller than recommended ducting will adversely affect the designed performance as regards airflow and noise levels.

Ala
Page 6

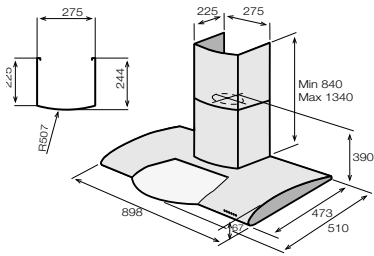

Cube
Page 7

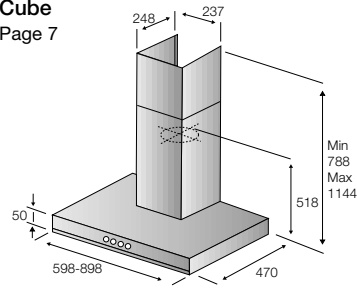

Feeling
Page 8

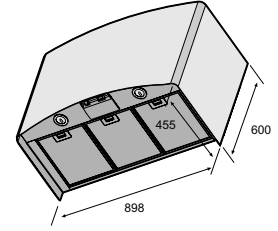

Glacier
Page 9

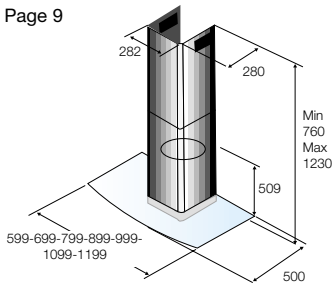

Igloo
Page 10

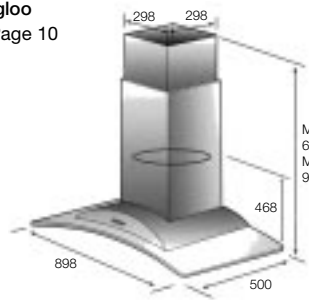

Key
Page 11

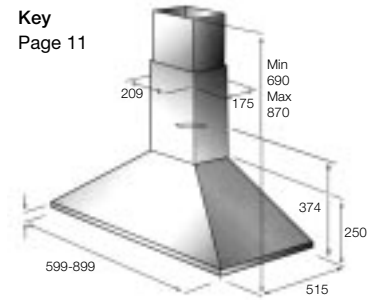

Polar
Page 12

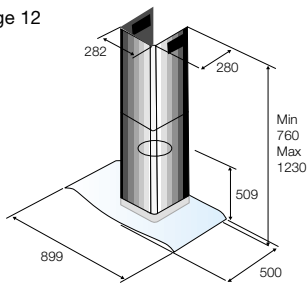

Spot
Page 13

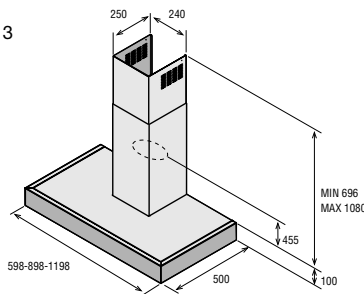

Stone
Page 14

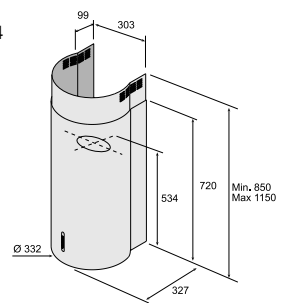

Tamaya
Page 15

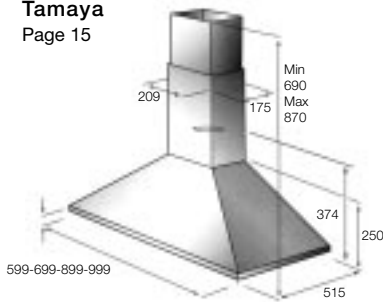

Tonda
Page 16

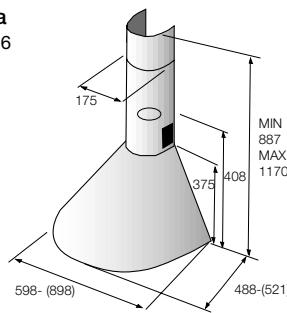

Tuscan
Page 17

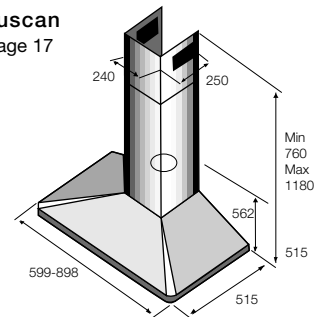

Typhoon
Page 18

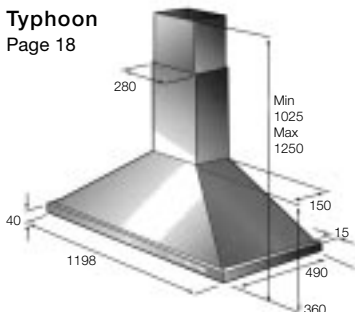

Zephyr
Page 19

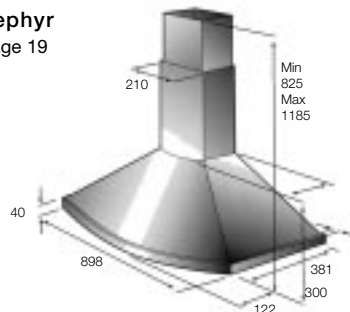

Fiji
Page 20

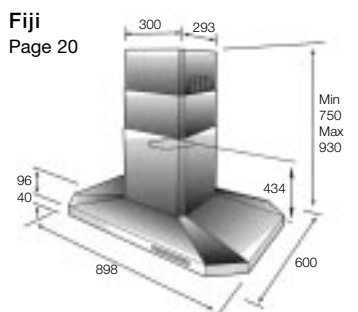

Free Spot Island
Page 21

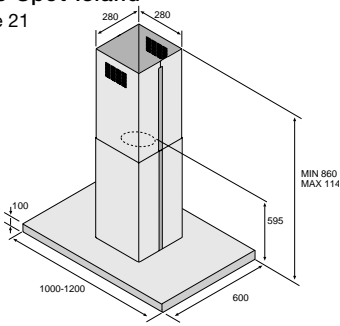

Glacier Island
Page 22

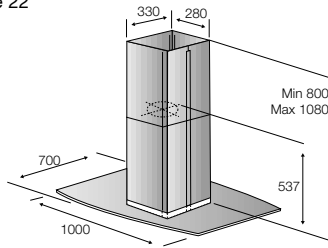

Iceberg Island
Page 23

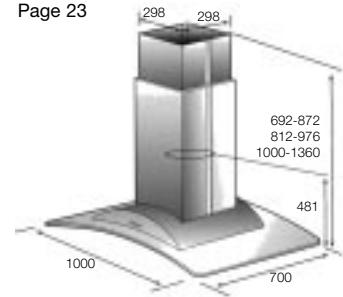

Tuscan Island
Page 24

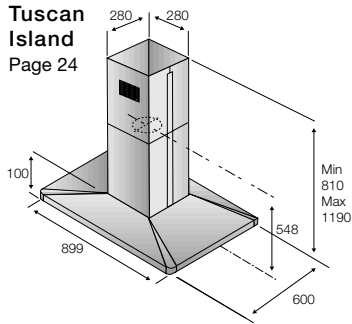

Hydra Corner
Page 25

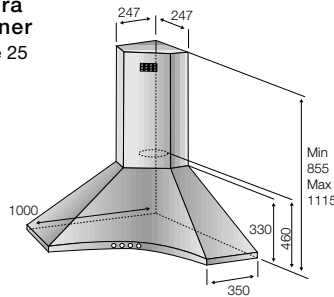

Cove
Page 26

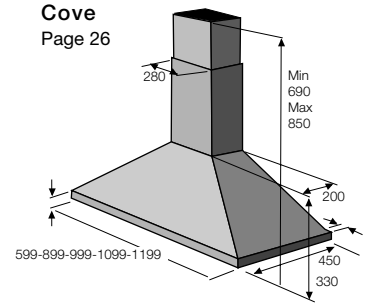

Classic
Page 26

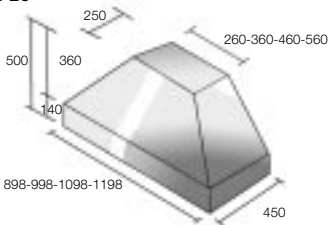

Pro Anglo
Page 27

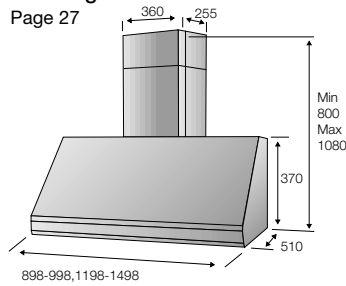

Copper and Brass Canopies
Page 27

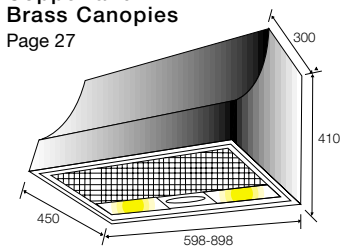

Built in Ultra 80
Page 28

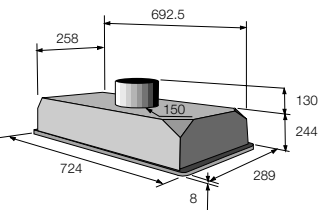

Built in Remote 60 & 80 Page 28
Built in Super Twin 60 & 80 Page 29
Built in Super 60 Page 30
Built in 52 Page 30

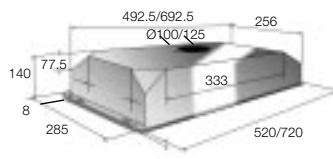

Built in Deluxe 60
Page 29

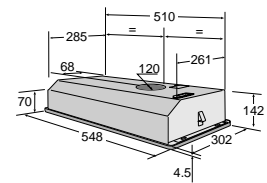

Integrated Ultra Page 31
Integrated Super Page 31
Integrated 60 & 90 Page 32

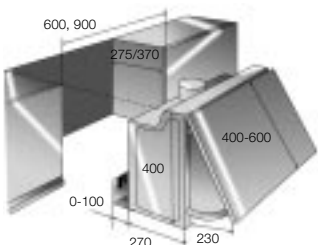

Slide Away Page 32

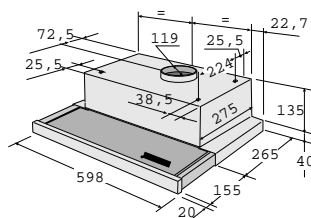

Concorde & Concorde Twin
Page 33

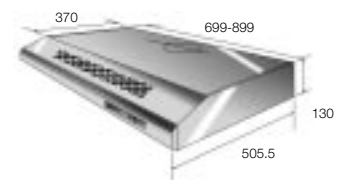

Chic
Page 33

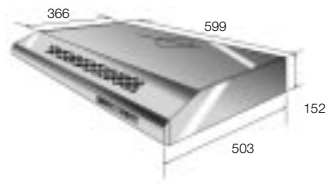

Backplate
Page 34

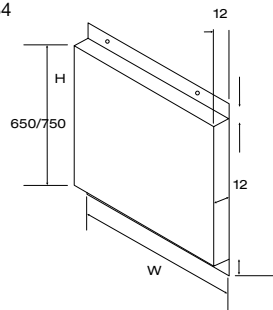
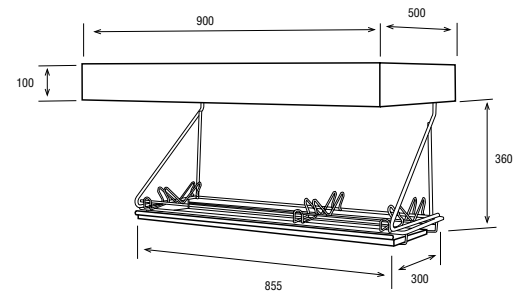

Plate Rack and Shelf
Page 34



The line drawings are provided as a guide only. For full installation dimensions, please refer to the documentation supplied with the appliance.

Cooker Hoods

Technical Specification

| Model | Colour | Extraction | Recirculate | Speed | Lights | Grease Filter | Charcoal Filter | DK 6/100 required if recirculating | Ducting Size mm | Extraction Free Air m ³ /h | Extraction to IEC61591 m ³ /h | DBA | Min Above Electric | Min Above Gas | External Motor Vers. Available | Max Rating watts |
|--|----------------|------------|-------------|----------|--------|---------------|---------------------------|------------------------------------|-----------------|---------------------------------------|--|-------------|--------------------|---------------|--------------------------------|------------------|
| ELICA CONCEPT | | | | | | | | | | | | | | | | |
| Ala | SS/Glass | • | • | 4 | 2Fl | Alum | Op.extra CF/261 | • | 150 | 750 | 630 | 46-64 | 650 | 700 | | 220 |
| Cube | SS/Glass | • | • | 3 | 2Ha | SS | Op.extra CF/262 or CF/195 | • | 150 | 750 | 630 | 46-64 | 650 | 700 | • | 220 |
| Feeling | SS | • | • | 3 | 2Ha | Alum | Op.extra CF/200 | | 150 | 750 | 630 | 46-64 | 650 | 700 | | 220 |
| Glacier | SS/Glass | • | • | 3 | 2Ha | SS | Op.extra CF/262 or CF/195 | • | 150 | 750 | 630 | 46-64 | 650 | 700 | • | 220 |
| Igloo | SS/Glass | • | • | 3 | 2Ha | Alum | Op.extra CF/160 | • | 150 | 750 | 630 | 46-64 | 650 | 700 | | 240 |
| Key | SS | • | • | 3 | 2Ha | Alum | Op.extra CF/200 | | 150 | 750 | 630 | 46-64 | 650 | 700 | | 220 |
| Polar | SS/Glass | • | • | 3 | 2Ha | SS | Op.extra CF/262 or CF/195 | • | 150 | 750 | 630 | 46-64 | 650 | 700 | • | 220 |
| Spot | SS | • | • | 3 | 2Ha | Alum | Op.extra CF/262 or CF/195 | • | 150 | 750 | 630 | 46-64 | 650 | 700 | | 220 |
| Stone | SS | • | • | 3 | 2Ha | SS | Op.extra CF/262 or CF/195 | • | 150 | 750 | 630 | 46-64 | 650 | 700 | | 220 |
| Tamaya | SS | • | • | 3 | 2 | Alum | Op.extra CF/200 | | 125 | 480 | 430 | 49-64 | 650 | 700 | | 250 |
| Tonda | SS | • | • | 3 | 2 | Alum | Op.extra CF/200 | | 125 | 480 | 430 | 49-64 | 650 | 700 | | 250 |
| Tuscan | SS | • | • | 3 | 2Ha | SS | Op.extra CF/262 or CF/195 | • | 150 | 750 | 630 | 46-64 | 650 | 700 | | 220 |
| Typhoon | SS | • | • | 4 | 3Ha | Alum | Op.extra 2xCF/150 | | 125 | 600 | 500 | 53-73 | 650 | 700 | | 246 |
| Zephyr | SS | • | • | Variable | 2 | SS | Op.extra CF/150 | | 125 | 480 | 440 | 51-71 | 650 | 700 | | 295 |
| ELICA CONCEPT ISLAND HOODS | | | | | | | | | | | | | | | | |
| Fiji Island | SS | • | • | 4 | 2Fl | Alum | Op.extra CF/160 | • | 150 | 750 | 630 | 50-70 | 650 | 700 | | 240 |
| Free Spot Island | SS | • | • | 3 | 4Ha | Alum | Op.extra CF/262 or CF/195 | • | 150 | 750 | 630 | 43-59 | 650 | 700 | | 260 |
| Glacier Island | SS/Glass | • | • | 3 | 4Ha | SS | Op.extra CF/262 or CF/195 | • | 150 | 750 | 630 | 46-64 | 650 | 700 | • | 260 |
| Iceberg Island | SS/Glass | • | • | 3 | 4Ha | Alum | Op.extra CF/160 | • | 150 | 750 | 630 | 46-64 | 650 | 700 | | 280 |
| Tuscan Island | SS | • | • | 3 | 4Ha | SS | Op.extra CF/262 or CF/195 | • | 150 | 750 | 630 | 46-64 | 650 | 700 | | 260 |
| ELICA CONCEPT CORNER HOODS | | | | | | | | | | | | | | | | |
| Hydra Corner | SS | • | • | 3 | 4Ha | Alum | Op.extra CF/200 | • | 150 | 750 | 630 | 46-64 | 650 | 700 | | 240 |
| RANGE STYLE HOODS/ CANOPIES | | | | | | | | | | | | | | | | |
| Pro-Anglo 90 | SS or Colour | • | • | 3 | 2 | Alum | Not applicable | | 150 | 480/1200 | 440/850 | 54-69/33-51 | 650 | 750 | • | varying |
| Pro-Anglo 120/150 | SS or Colour | • | • | 3 | 2 | Alum | Not applicable | | 2x 150 | 960/2400 | 880/1700 | 54-69/33-64 | 650 | 750 | • | varying |
| Cove | SS or Colour | • | • | 3 | 2 | Alum | Op.extra 2xCF48 | | 125 | 480/1200 | 440/850 | 54-69/33-51 | 650 | 750 | • | varying |
| Classic | SS or Colour | • | • | 3 | 2 | Alum | Op.extra 2xCF48 | | 125 | 480 | 440 | 54-69 | 650 | 750 | • | 320 |
| BUILT-IN HOODS | | | | | | | | | | | | | | | | |
| Built In Ultra | Blk/Gr | • | • | 4 | 2Ha | Alum | Op.extra CF/200 | | 150 | 700 | 600 | 53-69 | 650 | 750 | | 240 |
| Built In Super Twin 80 | Blk/Wht | • | • | 3 | 2 | Alum | Op.extra 2xCF/48 | | 125 | 480 | 440 | 54-69 | 650 | 750 | | 320 |
| Built In Remote 60 or 80 | Grey | • | • | Variable | 2Ha | Alum | Not applicable | | 150 | 1200 | 850 | 33-51 | 650 | 750 | • | 226 |
| Built In Deluxe | SS | • | • | Variable | 1Fl | SS | Op.extra CF/150 | | 125 | 480 | 440 | 51-71 | 650 | 700 | | 295 |
| Built In Super Twin 60 | Blk/Wht/Gr | • | • | 3 | 2 | Alum | Op.extra 2xCF/48 | | 125 | 480 | 440 | 54-69 | 650 | 750 | | 320 |
| Built In Super 60 | Blk/Wht | • | • | 3 | 2 | Alum | Op.extra CF/48 | | 100 | 280 | 250 | 53-65 | 650 | 750 | | 200 |
| Built In 52 | Blk/Wht/Gr | • | • | 3 | 2 | Paper | Op.extra CF/48 | | 100 | 280 | 250 | 53-65 | 650 | 750 | | 200 |
| INTEGRATED HOODS | | | | | | | | | | | | | | | | |
| Integrated Ultra | Grey | • | • | 4 | 1Fl | Alum | Op.extra CF/150 | | 125 | 540 | 480 | 55-68 | 650 | 700 | | 260 |
| Integrated Super | Grey | • | • | 3 | 2 | Alum | Op.extra CF/150 | | 100 | 300 | 270 | 50-62 | 650 | 700 | | 240 |
| Integrated 60 | Brn/Wht/Gr | • | • | 3 | 2 | Paper | Op.extra CF/34 | | 100 | 270 | 240 | 44-56 | 650 | 700 | | 200 |
| Integrated 90 | Grey | • | • | 3 | 2 | Paper | Op.extra CF/34 | | 100 | 270 | 240 | 44-56 | 650 | 700 | | 200 |
| Slide Away | Grey | • | • | 3 | 1 | Alum | Op.extra CF/48 | | 125 | 270 | 240 | 44-56 | 650 | 700 | | 200 |
| CONVENTIONAL HOODS | | | | | | | | | | | | | | | | |
| Concorde | Blk/Wht/Blk-SS | • | • | 3 | 2 | Paper | Inc. CF/190 | | 100 | 250 | 220 | 52-67 | 650 | 700 | | 200 |
| Concorde Twin 60/ 90 | Blk/Wht/SS | • | • | 3 | 2 | Alum | Inc. CF/190 | | 125 | 400 | 360 | 55-69 | 650 | 700 | | 320 |
| Chic | Blk/Wht | • | • | 3 | 2 | Paper | Inc. CF/50 | | 100 | 230 | 210 | 51-61 | 650 | 700 | | 140 |
| EXTERNAL MOTORS (450mm x 480mm high x 170mm deep) | | | | | | | | | | | | | | | | |
| | SS | • | • | | | | Not applicable | | 150 | 1200 | 850 | 38-50 | | | • | 220 |

*IEC61591 tested with 2.5 meters of ducting. ** Minimum height above gas for hobs 11.3kw or less. For higher rated hobs please seek further advice

Elica Cooker Hood

Elica has total commitment to service, quality and innovation and are proud to supply the world's finest cooker hoods.

Your Guarantee





















Elica cooker hoods are designed for use in domestic kitchens and are guaranteed for 2 years against faulty material or workmanship, protecting your hood against mechanical or electrical failure.

Installation

Your cooker hood should be installed by a qualified engineer. If the hood is to be ducted to the outside, it is important that the correct size ducting is used. This will be determined by the ducting connector of the hood and as indicated in this brochure.

To simplify installation Elica have developed their 'Smart' technology and incorporated it in many of our models. Smart utilises the practical system used for attaching kitchen cupboards making it simple to perfectly align the hood with the rest of the kitchen. Smart products can also use the long life filter if ducting the hood is not possible.

Symbol key

| | | | | | |
|--|--|---|--|--|--|
|  Width |  Finish |  Remote control |  Colours |  Control ball |  Touch control |
|  Push button |  Touch screen |  Visual display |  Slider control |  Automatic sensor technology |  Meteo technology |
|  Back up lighting |  Neon |  Optical fibre |  Halogen |  Candle bulb |  IX Stainless steel |
|  VT Glass |  AL Aluminium |  A Painted steel |  External motor | | |

Whilst every effort is made to ensure that the information contained in this brochure is correct at the time of going to press, D R Cooker Hoods Ltd cannot be held responsible for any errors or omissions.

Specifications may differ from those described or illustrated and D R Cooker Hoods Ltd reserve the right to change specification without prior notice.

Due to printing limitations colours and finishes are indicative only. If particular features, colours or sizes are important to you, please check with your Elica retailer prior to purchasing.



D R Cooker Hoods Ltd
2 Alpha Road
Aldershot
Hampshire
GU12 4RG

Telephone: 01252 351111
Fax:01252 311608

sales@drcookerhoods.co.uk
www.elica.co.uk