

QUCPB

Wireless Recessed & Surface Mounted PIR Sensor Instructions 70*80mm



Specifications

Switch Type: PIR Sensor
Body Colour: Black
Power Supply: 1 x CR123A Battery (included) or/and AC 200-240V 50/60Hz
Battery Life: Up to 2 years
Communicating Frequency: RF 433Mhz
Control Distance: up to 30m
Control Method: Pairing with Quinetic Controllers
IP Rating: IP20 (Indoor Use Only)
Detection Range: up to Ø8m
Coverage Area: 30m² (324ft²) to 62m² (676ft²)
Lux Level: 10-2000lux
Detection Angle: 360°
Time Range: 3 Seconds to 30 Minutes
Installation Height: 2.4 to 3.6 m (8 to 12 feet)
Installation Method: Recessed Installation (cut-out Ø75mm) or Surface Mounted
Indicator Light: Green - Pairing/Motion Detection
 Red - Low Battery
Operating Temperature: -10°C ~ +50°C
Warranty: 3 Years
 Read the instructions carefully before installation

Product Description

The QUCPB Quinetic ceiling PIR can be installed surface mounted or recessed. It is powered by a CR123A battery (included) and can also be powered by an AC 200-240V power supply. Once the ceiling PIR is paired with a Quinetic wireless receiver, it can turn ON the light/load by wireless control after sensing a person and turn OFF the light/load when the person leaves the area. It is suitable for home, classroom, office, warehouse or other places.

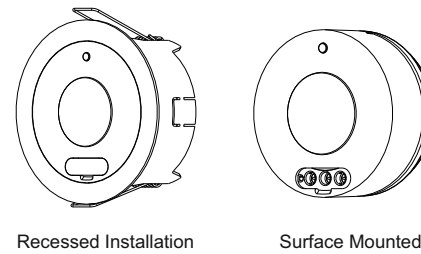

The PIR can be separated from the recessed base for surface mounted installation by pressing the buckles at both ends of the base to detach it.

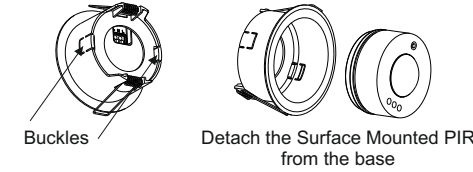

Power Supply Instructions

- The PIR can be powered by 1 x CR123A battery (included) or/and wired to AC 200-240V power supply.
- When using both AC 200-240V (wiring method) and battery power (as a backup power supply), the QUCPB ceiling PIR will use the AC power supply as a priority and it will not consume the battery. When the AC 200-240V power supply is disconnected, the PIR will automatically switch to the battery power supply. Once the AC 200-240V power supply is restored, it will automatically switch back to AC and it will no longer consume the battery.

Wiring and Battery Installation

Separate the PIR from the recessed base by pressing the buckles at both ends to access the AC terminals. Connect the PIR to an AC 200-240V power supply using the wiring diagram below:

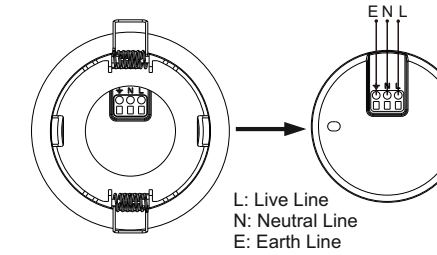

Installing / Replacing the Battery

To install the CR123A battery or to replace it if the PIR control becomes insensitive after a period of time or the control distance becomes much shorter (When the battery level is under 10% a Red LED indicator will flash quickly) follow the steps on the next page:

- Separate the PIR from the recessed base by pressing the buckles at both ends (Fig. 1).
- Turn the PIR counter-clockwise to separate it from the base and open the battery compartment (Fig. 2).

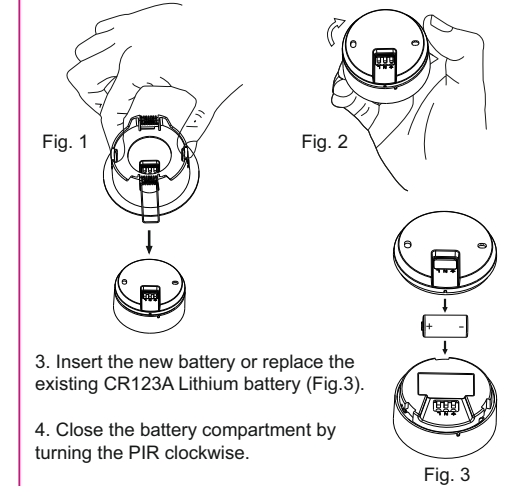

- Insert the new battery or replace the existing CR123A Lithium battery (Fig.3).
- Close the battery compartment by turning the PIR clockwise.

Installation

1. Recessed Installation

Cut a 75mm hole in the ceiling ensuring that it does not infringe with electrical cables, water/gas pipes or ceiling joists. Connect the mains supply to the PIR and/or install the CR123A battery. Push back the positioning springs of the PIR and install it into the hole in the ceiling. Once the positioning springs are folded, the PIR is fixed into the ceiling.

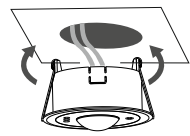

2. Surface Mounted

Step 1: Rotate the PIR counter-clockwise and separate it from the base, then fix the base on the ceiling using the provided screws.

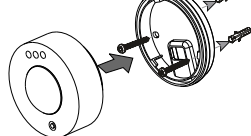

Step 2: Connect the mains supply to the PIR and/or install the CR123A battery. Fix the PIR to the base by rotating it clockwise.

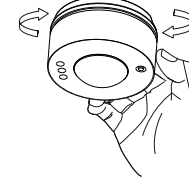

NOTE: For best results fix the sensor on a solid surface 2.4 - 3.6m above ground.

PIR Key Description

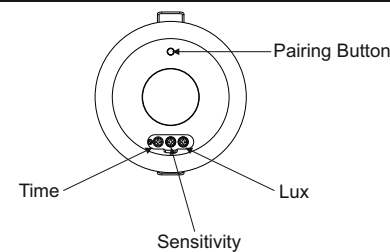

Pairing Method

Step 1: Press and hold the pairing button on the PIR sensor for 3 seconds; the green LED indicator light will flash slowly (once per second) and then release the button.

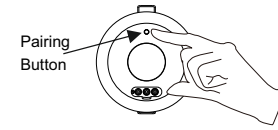

Step 2: Press the pairing button on the Quinetic receiver for 3 seconds, the receiver indicator will start flashing slowly (once every second) and then release the button. The receiver enters in pairing mode.

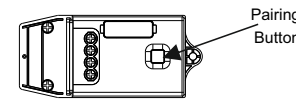

Step 3: Press the pairing button on the PIR sensor once; after the indicator on the receiver stops flashing, the pairing is successful. The PIR will control the light automatically by turning it on when a person is detected, and the light will automatically be turned off when the person leaves the area.

Clear Pairing

Long press the pairing button on the receiver for 10-15 seconds (depending on the model), until the red indicator light goes out. The pairing with the PIR sensor will be cleared.

PIR Sensor Adjustments

Remove the silicone cover to access the knobs and use them to adjust the lux level, the sensitivity and the delay time. Turn the knobs clockwise to increase the value, or counter-clockwise to decrease the value.

LUX ADJUSTMENT

LUX is the setting for the ambient light level below which the PIR sensor will start operating the lights when it senses movement. Simply set the LUX control knob from night time (10lux) to daylight (2000lux).

SENSITIVITY ADJUSTMENT

Adjust the control knob clockwise to increase the detecting range (0 - Ø8m range) or anti-clockwise to decrease the detecting range.

TIME ADJUSTMENT

Adjust the knob to control how long the light will stay on after the last movement has been detected. Turn the control knob clockwise to increase the delay time (up to about 30 minutes) or anti-clockwise to decrease the time (down to about 3 seconds).

Troubleshooting

- If the pairing does not work, first check if the indicator light is lit. Follow the pairing steps to re-pair the sensor.
- If the sensor does not respond, check the following:
 - The battery or AC power supply are present.
 - The battery is not low level. If the red indicator light flashes, replace the battery.
 - Make sure that the distance from the sensor to the Quinetic controller does not exceed the maximum controlling distance.
 - Ensure that the sensor is mounted correctly, facing the desired detection area.
 - Ensure that the Lux level and Sensitivity are set up correctly.

Product Dimensions

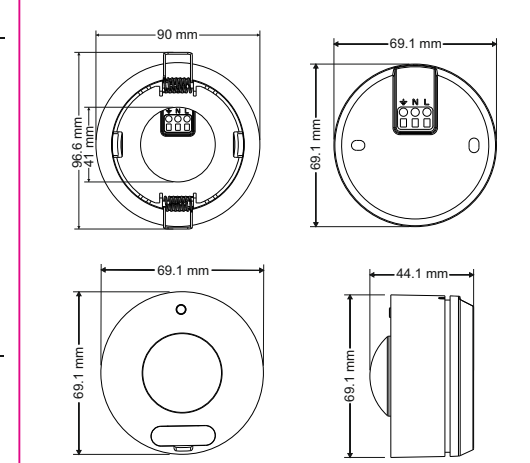
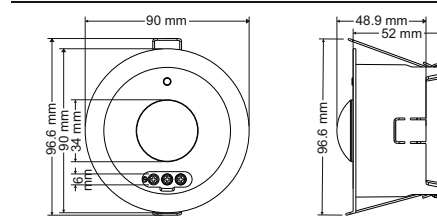

*For more information about pairing, instructions and troubleshoot please visit www.tlc-direct.co.uk website.