

QUPIR

Wireless PIR Sensor Instructions 80*60mm

QUINETIC



QUPIRB
Wireless PIR Sensor
Installation Instructions

Specifications

Wireless PIR Sensor Technical Parameters:

- Switch Type:** PIR Sensor
- Power Supply:** 1 x CR2450 Battery (included)
- Battery Life:** Up to 3 years
- Communicating Frequency:** RF 433Mhz
- Control Distance:** Up to 80m Outdoor, 30m indoor
- Control Method:** Pairing with Quinetic Controllers
- IP Rating:** IP65
- Sensitivity Range:** 25%-100%
- Lux Level:** 10-3500lux
- Time Range:** 3sec to 10min
- Detection Angle:** 120°
- Detection Distance:** up to 8m
- Operating Temperature:** -10°C ~ +45°C
- Operating Humidity:** 10% - 95% RH
(Non Condensing)
- Installation:** Screws (included), Fixed bracket
- Product Dimensions:** 55X55X87.9mm
- Warranty:** 3 Years

Read instructions carefully before installation

Installation:

Screw Installation:

Use the provided screws to install the infrared sensor on a wall or on the ceiling, indoor or outdoor (Fig.1).

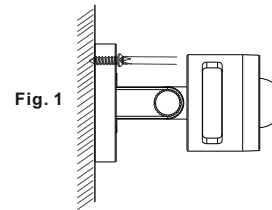

Choosing a Mounting Location:

- For the best results, fix your sensor on a solid surface, 1.8~2.5M above the ground.
- When choosing the mounting position consider that the sensor is more sensitive to motion across the detection field (A) and less sensitive to motion directly towards the sensor (B)(Fig.2).

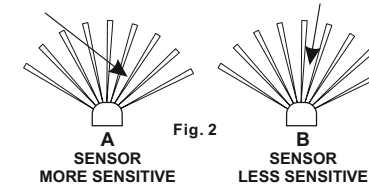

Outdoor Mounting Location:

- For outdoor a location under eaves is preferable.
- Avoid aiming the motion sensor at pools, heating vents, air conditioners or objects that may change temperature rapidly.
- Do not allow sunlight to fall directly on the front of unit.
- Try to avoid pointing the unit at trees or shrubs or where the motion of pets may be detected.

Pairing Method:

Before pairing the PIR sensor, open the battery compartment and **remove the plastic protection film from the battery** to activate the PIR.

Step 1: Press and hold the pairing button on the PIR sensor (Fig.3) for 3 seconds; the LED sensor indicator will flash slowly (flashing once per second) and then release the button.



Fig. 3 Pairing Button

Step 2: Press the pairing button on the controller (Fig.4) for 3 seconds, the controller indicator flashes slowly (flashing once every second) and then release the button. The controller enters the pairing mode.

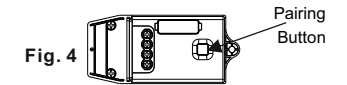
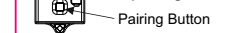

Fig. 4 Pairing Button

Step 3: Press the pairing button on the PIR sensor once; after the indicator on the controller stops flashing, the pairing is successful. This pairing method will control the light automatically by turning it on when a person is sensed, and the light will automatically be turned off if the person leaves the area.

Clear Pairing:

Long press the pairing button on the controller for 10-15 seconds (depending on the model), until the red indicator light goes out. The pairing with the PIR sensor will be cleared.



PIR Sensor Setting:

Remove the cover and use the knobs on the top of the QUPIR sensor to adjust the lux level, the sensitivity and the delay time. Turn the knobs clockwise to increase the value, or counter-clockwise to decrease the value. (Fig.5)

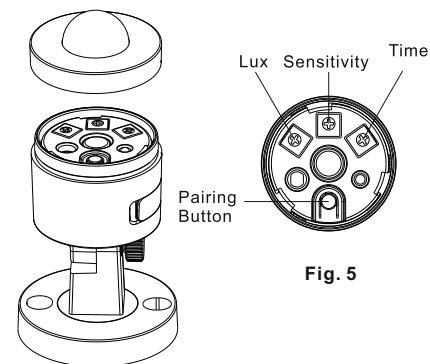

Fig. 5

LUX ADJUSTMENT

The LUX adjustment determines at what light level the PIR sensor will start operating the lights when it senses movement. Simply set the LUX control knob from night time (10lux) to daylight (3500lux).

SENSITIVITY ADJUSTMENT

The sensitivity may be adjusted to compensate for seasonal variations in temperature and to reduce unwanted triggering.

Adjust the control knob clockwise to increase the detecting distance (up to 8m) or anti-clockwise to decrease the detecting distance.

TIME ADJUSTMENT

The TIME adjustment controls how long the light will stay on after the last movement has been detected. Turn the control knob clockwise to increase the delay time (up to about 10 minutes) or anti-clockwise to decrease the time delay (down to about 3 seconds).

Replacing the Battery:

If the PIR remote control becomes insensitive after a period of time or the control distance becomes much shorter please replace the battery.

To replace the battery follow the steps below:

1. Pull the battery drawer.(Fig.6).
2. Replace the battery with a CR2450 Lithium battery.
3. Insert the drawer back into his initial position.

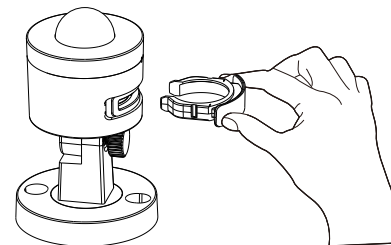
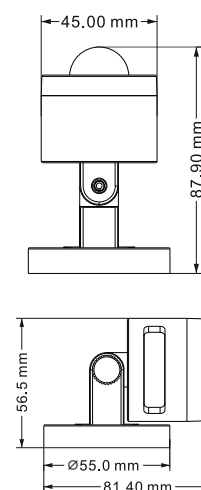

Fig.6 Replacing the battery

Product dimensions:



Troubleshooting:

1. If pairing does not work, first check if the indicator light is lit. Follow the pairing steps to re-pair the sensor.
2. If the sensor does not respond check the following:
 - The battery transparent film has been removed.
 - The battery is not low level. If the red indicator light flashes, replace the battery.
 - Check the that distance from the sensor to the Quinetic controller does not exceed the maximum controlling distance.
 - Ensure sensor is mounted correctly, facing the desired detection area.
 - Ensure the Lux level and Sensitivity are set up correctly.

QUINETIC

*For more information about pairing, instructions and troubleshoot please visit www.tlc-direct.co.uk website.