

COMBI 206 LG / 3xWAGO 221-413

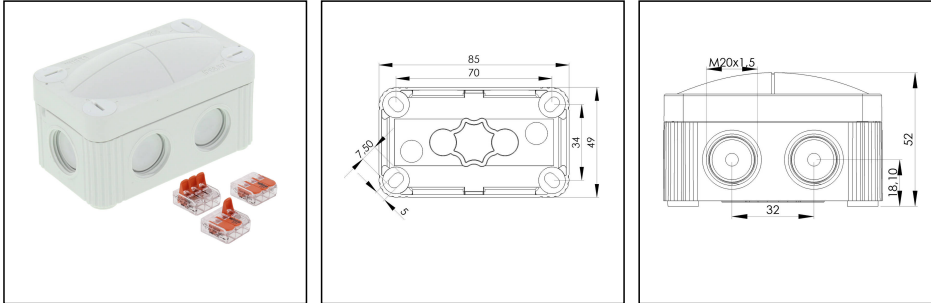

Products may differ in size, colour and appearance to those shown. If you require further information or customisation, please contact us directly.

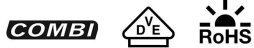

Material	Polypropylene
Material sealing gasket	TPE
Temp. range min	-30 °C
Temp. range max	100 °C
Temperatures during install.	-5 °C - 60 °C
Protection class	IP66 / IP67
Glow wire test	750 °C
Voltage	400 V
Rated cross section	1,5 mm ²
Terminals/poles	4 mm ²
Fixing	4 internal openings
Ø cable diameter min	3 mm
Ø cable diameter max	12 mm
External dimensions LxWxH	85 x 49 x 51mm
Using for cable gland	
Product Color	RAL 7035
Order no. RAL 7035	10109901
Type	COMBI 206 LG / 3xWAGO 221-413
Packing unit	10
EAN number	4007686103229
Tariff number	85369010
ETIM-Classification	EC002600

Remarks:

IP66: using the membrane entry

Your Contact:

WISKA UK Ltd.

Unit 7, Hurling Way · St. Columb Major Business Park · TR9 6SX, St. Columb Major, Cornwall · Great Britain

☎ +44-12-08816062 · 📠 +44-12-08816708

info@wiska.co.uk · www.wiska.co.uk

IP67: using the threaded entry together with ESKV cable gland

Equipment:

- 6 M20 threaded membrane entries
- 2 membrane cable entries through rear
- 4 captive cover screws
- including 3x WAGO 221-413 enclosed loose

Fixing:

With 4 internal openings outside of the sealing area

Recommended accessories

MP-S Mounting plate small	10105774
ZER 4-12 LG	10109800

09.01.2025

Your Contact:

WISKA UK Ltd.

Unit 7, Hurling Way · St. Columb Major Business Park · TR9 6SX, St. Columb Major, Cornwall · Great Britain

☎ +44-12-08816062 · 📠 +44-12-08816708

info@wiska.co.uk · www.wiska.co.uk

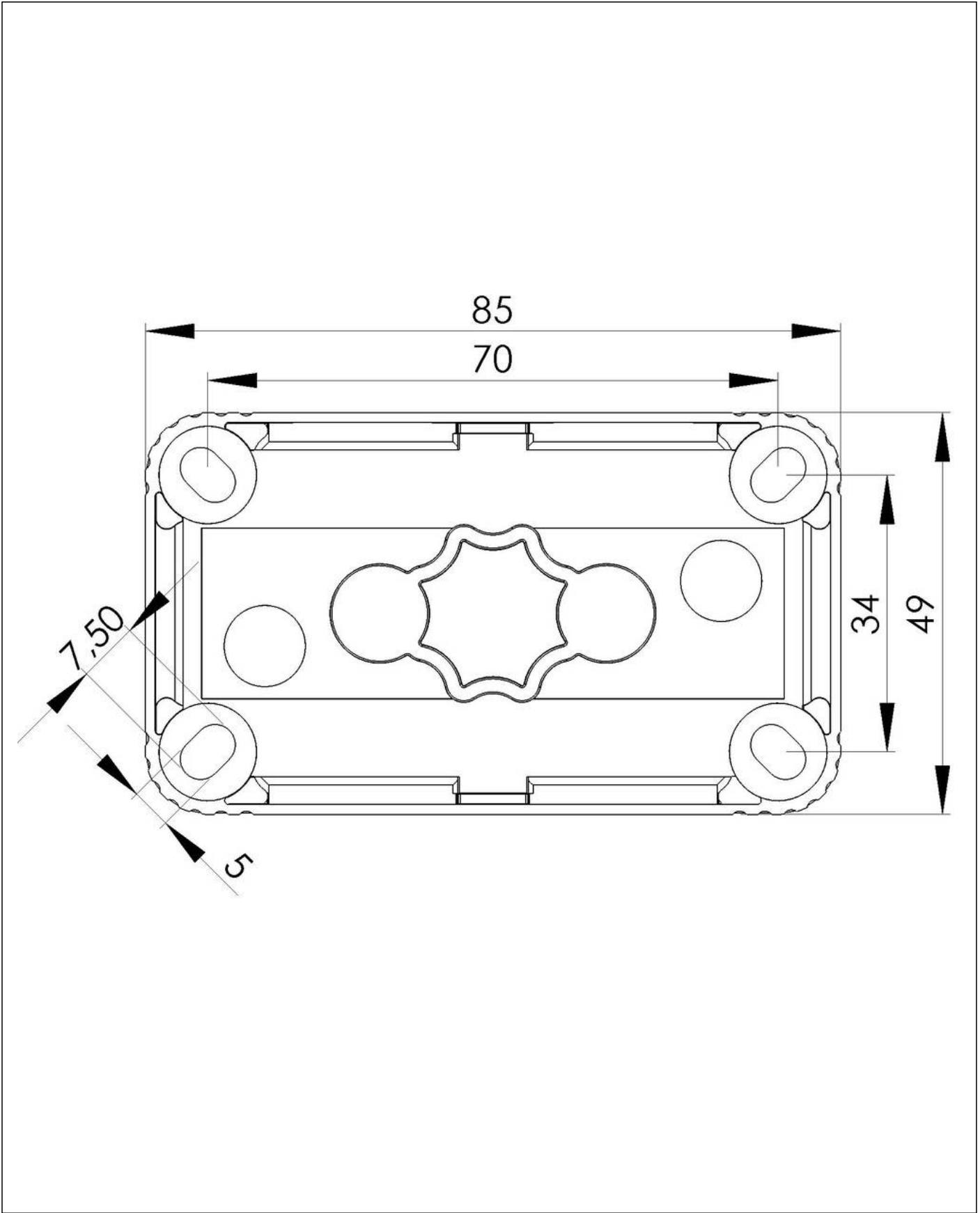

Your Contact:

WISKA UK Ltd.

Unit 7, Hurling Way · St. Columb Major Business Park · TR9 6SX, St. Columb Major, Cornwall · Great Britain

☎ +44-12-08816062 · 📠 +44-12-08816708

info@wiska.co.uk · www.wiska.co.uk

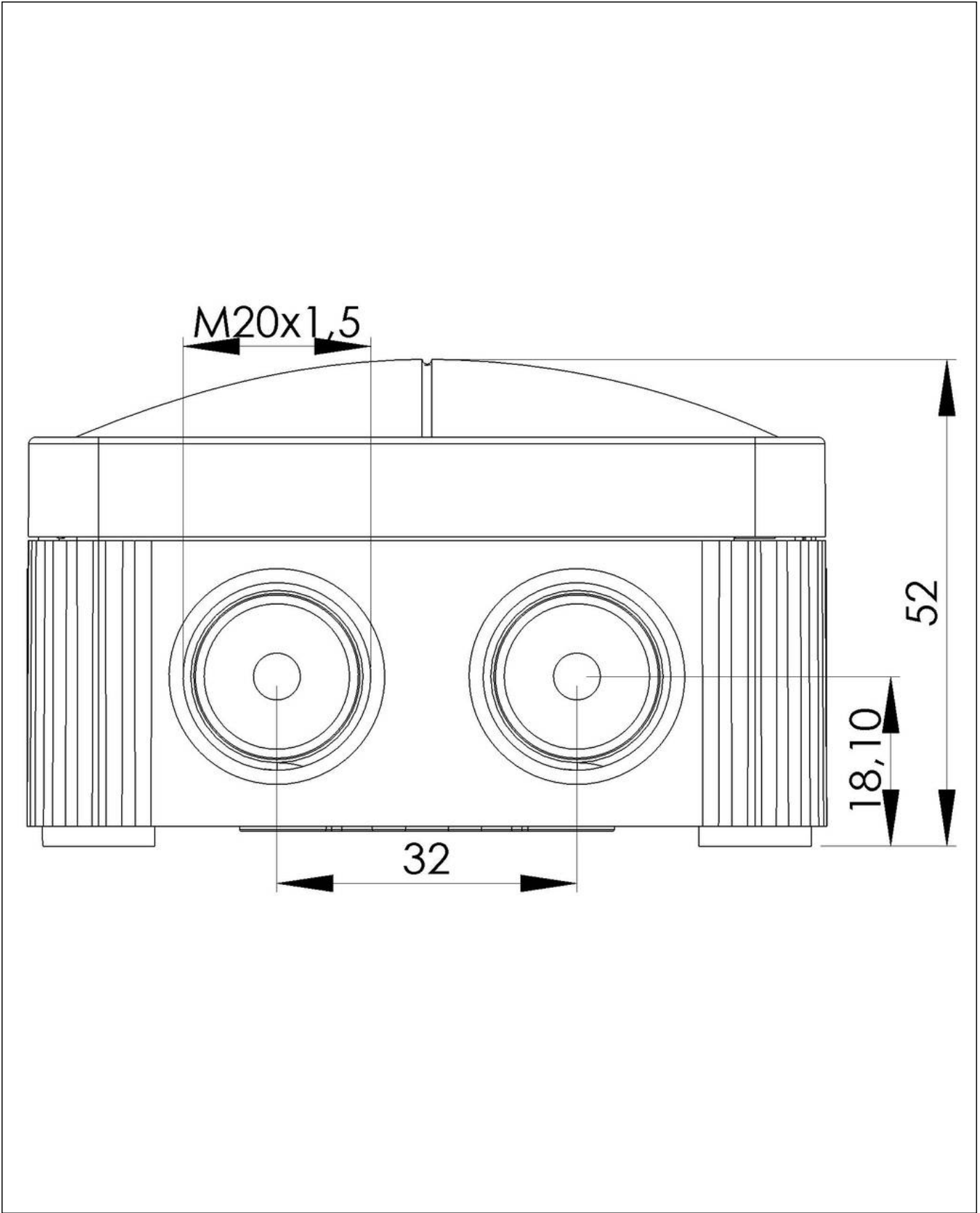

Your Contact:
WISKA UK Ltd.
Unit 7, Hurling Way · St. Columb Major Business Park · TR9 6SX, St. Columb Major, Cornwall · Great Britain
☎ +44-12-08816062 · 📠 +44-12-08816708
info@wiska.co.uk · www.wiska.co.uk