



GB

F

A

NL

D

I

EC6H FAN CONTROLLER

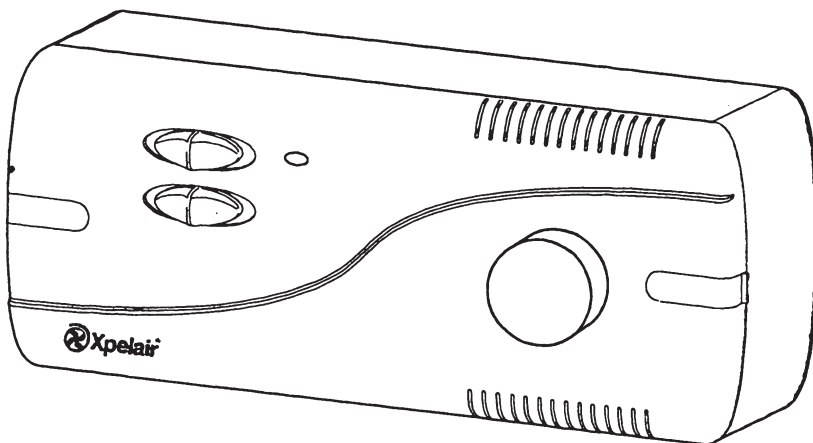

Installation and Operating Instructions

applied energy 

NOTE:

**CANADIAN CSA APPROVED MODEL.
120V 60Hz SPECIFICATION:**

**THIS UNIT IS DESIGNED EXCLUSIVELY FOR
RECESS MOUNTING AND IS THEREFORE
SUPPLIED FACTORY PREPARED FOR THIS
METHOD OF INSTALLATION.**

**THE UNIT IS FOR USE WITH TYPE B1 AND B2
PRODUCTS (SEE 'WORKING WITH THE FAN')
AND CAN BE USED TO RUN SIX 9" FANS OR
THREE 12" FANS BUT NOT A COMBINATION
OF BOTH.**

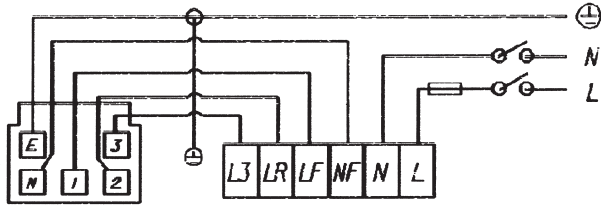
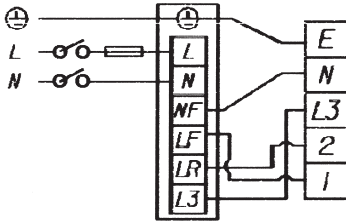
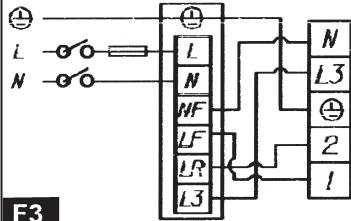
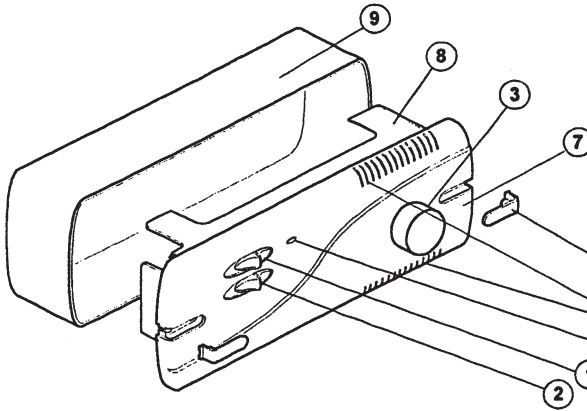
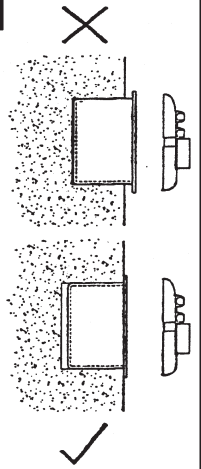
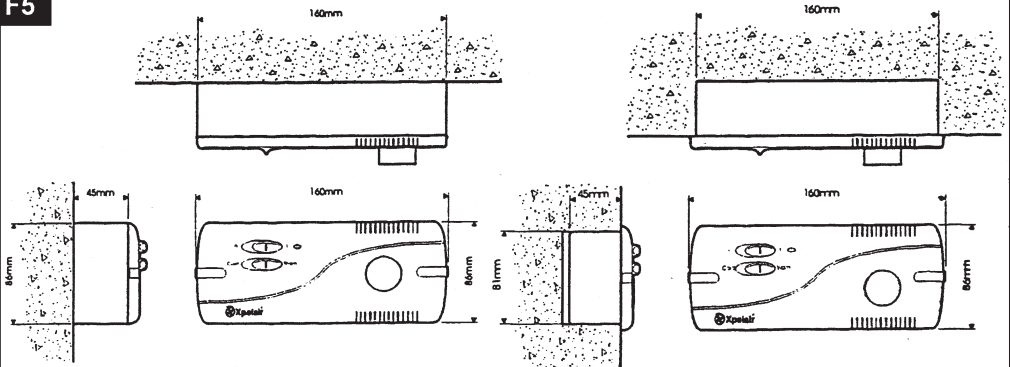
F1**F2****F3****F4****F6****F5**

Xpelair EC6H Fan Controller Installation and Operating Instructions

These Instructions are for the Installation and Operation of the EC6H Fan Controller only. For Fan Installation and Operating Instructions refer to literature provided with the appropriate fan.

General Information

Description

This appliance is designed to control the operation of Xpelair fans of the GX9, GX12, WX9, WX12, RX9 & RX12 ranges (wall & window mounted). The controller may be either surface mounted, or recess mounted within a metal wall box (not supplied). When used on a 220-240V supply the controller may be used to control up to six 9" fans, or four 12" fans, but not a combination of fan sizes.

Installing the Controller

These installation instructions are for the installation of the controller when used in combination with Xpelair supplied fans.

The controller must be installed to fixed wiring. Ensure the Main Electrical Supply matches the rating shown on the controller casing. An earth parking terminal is provided in the plastic wall box supplied.

All installation must be supervised by a qualified electrician. Installation and wiring must conform to current IEE wiring regulations (UK), or local appropriate regulations (other countries).

If you have any queries either before, during or after the installation of the controller, please do not hesitate to contact the UK Xpelair hotline (number on back page).

Customers outside the UK: contact your local Xpelair distributor.

What the installer will need

- A double pole isolating switch with a minimum contact gap of 3mm (Wall or Ceiling mounted).
- Suitably rated 5-core cable to connect the controller to the fan. If the fan is window mounted, use flexible cable. (Available from Xpelair)
- Suitably rated 3-core cable to connect the controller to the Main Electrical Supply.

For recess mounting:

A double gang metal wall box (min. depth 45mm), with knockouts suitably located, and integral earth stud (Refer Fig. 1 for knockout positions).

If using flexible cable, suitable glands incorporating cable clamps must be fitted to the knockouts in the Controller Box. (Refer to Fig. 1).

Location of the Controller

- Not where ambient temperatures are likely to exceed 50°C.
- If installed in a kitchen the Controller must not be mounted immediately above a cooker hood or eye level grill.
- When intended for use in possible chemical corrosive atmospheres, consult our Technical Service Department (Outside the UK contact your local Xpelair distributor).
- If installed in a shower room or bathroom the controller and isolating switch must be situated so that they cannot be touched by persons making use of the bath or shower.

Working with the Fan

Identifying Fan Type

For the purpose of these instructions current and previous versions of the fans are identified into Type A & Type B, as follows:



Type A1



Type A2



Type B1



Type B2

Preparing the Fan



If wiring to an existing installation isolate mains supply and remove applicable fuses prior to any electrical procedure.

If wiring to Type A fans

A link is fitted between terminals 2 and 3 in the fan socket, this must be removed before connecting the Controller. If you do not remove it, the Controller will be permanently damaged.

If wiring to Type B fans

There is no wire link to be removed.

If the fan is already installed

- 1 Ensure the power supply is isolated.
- 2 Disconnect the mains connections from the fan's terminal socket or from the terminal block.
- 3 Remove the existing wiring and make it safe.

If the fan is not yet installed.

- 1 Check that the fan electrical rating matches the power supply.

Wire the fan electrical connections

- 1 Where several fans are to be used, they must be wired in parallel using suitable junction boxes (not supplied).
- 2 Route the 5-core cable from the Fan to the Controller position.
- 3 Wire one end of the cable into the fan connections as shown thus:

FAN TYPE	DIAGRAM
Type A1	F1
Type A2	F2
Type B1/B2	F3

Table 1.

- 4 Leave the other end ready to be connected to the Controller.
- 5 Route the 3-core cable from the position of the isolating switch to the controller

Mounting the Controller

Remove the Cover and Mounting Frame

- 1 Detach the Fascia and Mounting Frame by removing the screw covers and two screws (Refer to Fig. 2a&b).
- 2 Check that the electrical rating shown inside the controller matches the power supply.
- 3 Make cable entry holes in the plastic or metal box by removing suitable knockouts (Refer to Fig. 1).

Mounting the Wall Box



Eye protection must be worn during all drilling & chiselling operations.



Check there are no buried Pipes or Cables in the wall or obstructions on the outside e.g. Electricity, Gas, Water.



If metal switch boxes are used, earthing regulations must be applied

If surface mounting

- 1 Insert suitable glands into the knockouts.
- 2 Feed both cables through the glands.
- 3 Fix the Plastic Wall Box to the wall, using the mounting holes provided.
- 4 Connect the earth lead to the parking terminal.

If recess mounting

- 1 Make a hole in the wall big enough to take the metal wall box. Discard the Plastic Wall Box.
- 2 Insert suitable glands into the knockouts.
- 3 Feed both cables through these glands.
- 4 Fix the Wall Box to the wall. Ensure that the flange of the mounting frame fits flush to the finished surface of the wall (Refer diagram F6).
- 5 Connect the earth lead to the metal wall box.

Wire the Controller electrical connections

- 1 Mount the Isolation Switch in accordance with the manufacturers instructions.
- 2 Wire the Controller to the Isolation Switch and to the Fan as shown in the appropriate diagram (Refer to Table 1).
- 3 Refit Fascia and Mounting Frame to Wall Box.
- 4 Refit the Screw Covers.

Connect to Power Supply

- 1 Ensure power supply is isolated and fuses are removed.
- 2 Route the Cable from the Isolating Switch to the point of connection to the power supply.
- 3 Make all connections within the Isolating Switch in accordance with the manufacturers instructions.
- 4 Following all local regulations make connection at point of power supply.
- 5 Make a final check to ensure all earth points are connected and all covers have been correctly replaced on the fan, controller and isolating switch.
- 6 Replace all fuses, and switch on the power supply.

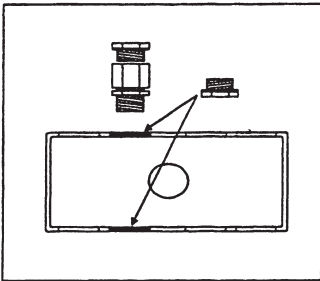

Fig. 1 : Cable Gland Positions

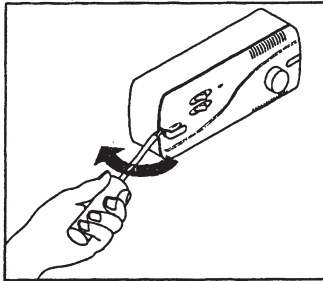

Fig. 2a : Removing screw covers

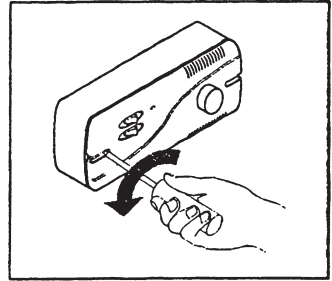

Fig. 2b: Removing fascia

Using your Controller

Operating the Controller

The Controller has the following features: (Refer to diagrams F1-F4).

- | | |
|---------------------------|--------------------------------|
| 1 On / Off switch | 8 Mounting Frame |
| 2 Intake / Extract switch | 9 Wall Box |
| 3 Speed Regulator | 10 Controller Terminal Block |
| 4 Indicator light | 11 Fan Terminal Block |
| 5 Ventilation slots | 12 Double Pole Isolator switch |
| 6 Screw cover | 13 Fuses |
| 7 Fascia | |

Looking after the Controller

Cleaning

- 1 Before cleaning isolate the Controller completely from the power supply.
- 2 Wipe the Cover carefully with a damp cloth.
- 3 Dry thoroughly.
- 4 Ensure ventilation slots are free from obstructions at all times.



- ◆ Never immerse the Controller in water or other liquids.
- ◆ Never use solvents to clean the Controller.
- ◆ Apart from cleaning, no other maintenance is required.

Do's and Don'ts

- Do read the entire instruction leaflet before commencing installation.
- Do install the controller with a double pole isolating switch.
- Do make sure that the mains supply is switched off before attempting to make electrical connections or carry out any maintenance or cleaning.

Guarantee - UK. (Customers outside UK - see international below.)

- The controller is guaranteed against defects for 3 years from the date of purchase.
- Please keep your purchase receipt.
- If you have any problems, contact Xpelair's Head Office at the address shown below.

Technical advice and service - UK. (Customers outside UK - see international below.)

Xpelair have a comprehensive range of services including:

- Free technical advice from Engineers on all aspects of ventilation.
- Free design service, quotations and site surveys.
- Service and maintenance contracts to suit all requirements.

Please ask for details:

- By telephone on Techline:
+44(0) 8709 000430
- By Fax on Techfax:
+44(0) 8709 000530
- At the address below:

Head Office, UK sales office and spares

GDA Applied Energy Ltd, Morley Way, Peterborough, PE2 9JJ, England

Telephone: +44(0) 1733 456789
Fax: +44(0) 1733 310606
Sales Hotline: +44(0) 8709 000420
<http://www.xpelair.co.uk>

International

Guarantee: Contact your local distributor or Xpelair direct for details.
Technical advice & service: Contact your local Xpelair distributor



applied energy ^{///GDA} 

Document No.: 567 2044 01 Rev C